

The electropumps NM, B-NM, NMS, B-NMS series comply with the European Regulation no. 547/2012 in force starting from 01.01.2013

### Materials

Components	NM, NMS	B-NM, B-NMS
Pump casing	Cast iron	Bronze
Lantern bracket NM	GJL 200 EN 1561	G-Cu Sn 10 EN 1982
Casing cover for NMS		
Lantern bracket NMS	Cast iron GJL 200 EN 1561	
Impeller	Cast iron	Bronze
	GJL 200 EN 1561	G-Cu Sn 10 EN 1982
	Brass P- Cu Zn 40 Pb 2 UNI 5705 for NM 32/12-16-20, NM 40/20, B-NM 32/125-160-200, B-NM 40/200	
Shaft	AISI 303 up to 2.2 kW	Cr Ni Mo steel
	AISI 430 from 3 kW to 75 kW	AISI 316
Mechanical seal	Carbon - Ceramic - NBR	
Counter-flanges	Steel Fe 430B UNI 7070	

### Construction

Close-coupled centrifugal pumps; electric motor with extended shaft directly connected to the pump up to 30 kW, new bracket construction for standard motors (stub-shaft construction) from 37 to 75 kW with integrated thrust bearing.

Pump casing with axial suction and radial delivery on top, main dimensions and performance according to EN 733.

NM(S): version with pump casing and lantern bracket in cast iron.  
B-NM(S): version with pump casing and lantern bracket/casing cover in bronze. (the pumps are supplied fully painted).

**Connections:** Flanges according to PN 10, EN 1092-2.

**Counter-flanges** (on request)

Sizes	Flanges
from NM 32/.. to NM 50/...	Screwed flanges EN 1092-1, PN 16
from NM 65/.. to NMS 100/...	Flanges for welding EN 1092-1, PN 10

### Applications

For clean liquids without abrasives, which are non-aggressive for the pump materials (solids content up to 0,2%).

For water supply.

For heating, air conditioning, cooling and circulation plants.

For civil and industrial applications.

For fire fighting applications. For irrigation.

### Operating conditions

Liquid temperature from -10 °C to +90 °C.

Ambient temperature up to 40° C.

Total suction lift up to 7 m.

Maximum permissible working pressure up to 10 bar.

Continuous duty.

### Motor

2-pole induction motor, 50 Hz (n ≈ 2900 rpm).

**NM, NMS:** three-phase 230/400 V ± 10% up to 3 kW;

400/690 V ± 10% from 4 to 75 kW.

Insulation class F. Protection IP 54 (IP 55 for NMS).

Motor suitable for operation with frequency converter from 2,2 kW.

**Classification scheme IE2 for three-phase motor from 0,75 kW.**

Constructed in accordance with: EN 60034-1; EN 60034-30.

### Special features on request

- Other voltages. - Frequency 60 Hz (as per 60 Hz data sheet).
- Protection IP 55.- Special mechanical seal.
- Packed gland (only for NM standard construction).
- Single-phase motor (NMM) up to 1,5 kW.
- Explosion proof construction in accordance with Directive 94/9 EEC (ATEX).
- Higher or lower liquid or ambient temperatures.
- Motor suitable for operation with frequency converter up to 1,5 kW.

### Coverage chart n ≈ 2900 rpm

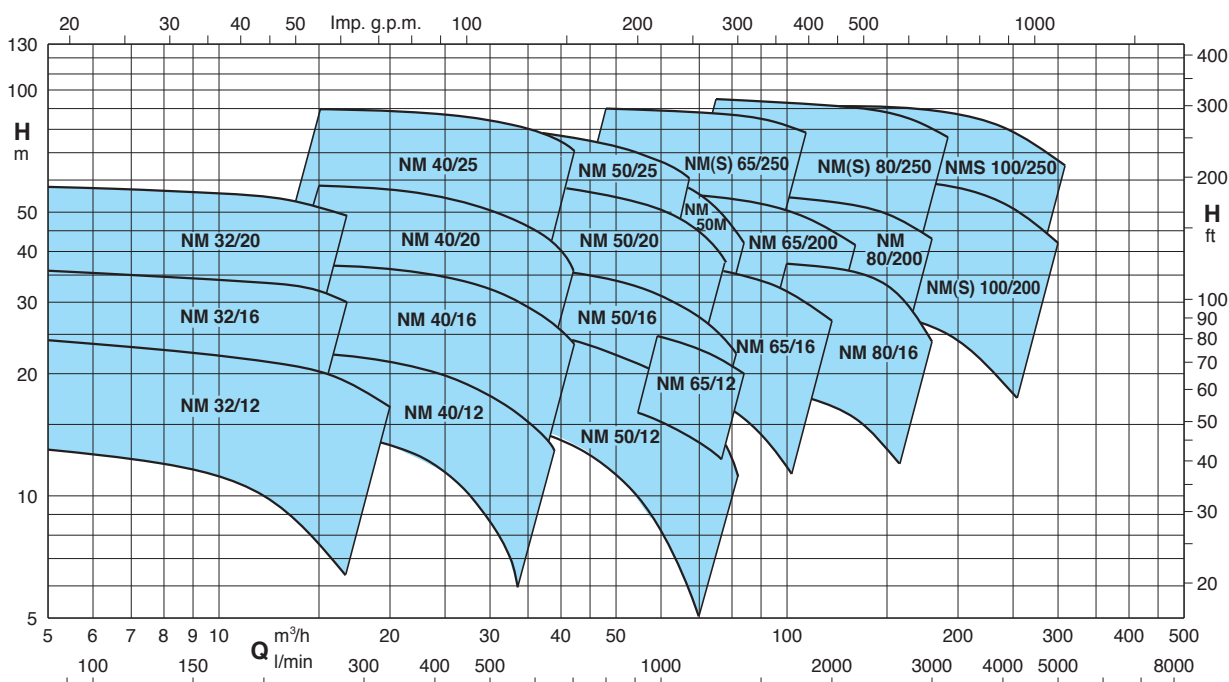

### Performance n ≈ 2900 rpm

B-NM	NM	P <sub>2</sub>		Q m <sup>3</sup> /h l/min	6,6	7,5	8,4	9,6	10,8	12	13,2	15	16,8	18,9	21	24	27	30
		kW	HP		110	125	140	160	180	200	220	250	280	315	350	400	450	500
					H m													
B-NM 32/12F	NM 32/12FE	0,55	0,75	H m	12,5	12,5	12	11,5	11	10	9	7,5						
B-NM 32/12D	NM 32/12DE	0,75	1		18	18	17,5	17	16,5	16	15,5	14						
B-NM 32/12A	NM 32/12AE	1,1	1,5		23	23	22,5	22	21,5	21	20,5	19						
B-NM 32/12S	NM 32/12SE	1,5	2		23,5	23,5	23	22,5	22	21,5	21	20,5	19	18,5	16,5	13		
B-NM 32/16B	NM 32/16BE	1,5	2		29,5	29,5	29	28,5	27,5	27	26	25*	22,5*					
B-NM 32/16A/A	NM 32/16A/A	2,2	3		35,5	35,5	35	34,5	34	33,5	33	32*	30*					
B-NM 32/20D/A	NM 32/20D/A	2,2	3		38	37,5	37	36	35	33,5	32							
B-NM 32/20C/A	NM 32/20C/A	3	4		45	44,5	44	43,5	42,5	41	40	38	36					
B-NM 32/20A/A	NM 32/20A/A	4	5,5		57,5	57	56	55,5	55	54,5	53,5	51,5	49					

B-NM	NM	P <sub>2</sub>		Q m <sup>3</sup> /h l/min	15	16,8	18,9	21	24	27	30	33	37,8	39	42	45	48	54
		kW	HP		250	280	315	350	400	450	500	550	630	650	700	750	800	900
					H m													
B-NM 40/12F	NM 40/12F/A	1,1	1,5	H m	14	13,5	13	12	11	9,5	8	6						
B-NM 40/12C	NM 40/12C/A	1,5	2		17,5	17	16,5	16	15	13,5	12	10,5	7,5	6,5				
B-NM 40/12A/A	NM 40/12A/B	2,2	3		22	22	21,5	21	20	19	18	16,5	14	13	11,5			
B-NM 40/16C/A	NM 40/16C/B	2,2	3		23	22,5	22	21,5	20	18,5	16,5	14,5	11	10				
B-NM 40/16B/A	NM 40/16B/B	3	4		29	28,8	28	27,5	26,5	25	23,5	21,5	18	17	14			
B-NM 40/16A/A	NM 40/16A/B	4	5,5		37	36,5	36,5	36	35	33,5	32	30,5	27	26	23,5	20	17	
B-NM 40/20D/A	NM 40/20D/A	4	5,5		39	38	37	35,5	33,5	30,5	27	22,5	14					
B-NM 40/20C/A	NM 40/20C/A	4	5,5		41,5	40,5	39,5	38	36	33,5								
B-NM 40/200B/A	NM 40/200B/A	5,5	7,5		50	49,5	48,5	47,5	45,5	43,5	41,5	37,5	30,5					
	NM 40/20AR/A	5,5	7,5		55	54,5	54	53	51	49								
B-NM 40/200A/A	NM 40/20A/A	7,5	10		57,5	57	56,5	55,5	54,5	52,5	50,5	48	42,5	40,5	35			
B-NM 4025/C/B	NM 40/25C/B	9,2	12,5		61	61	60,5	59,5	58,5	56,5	53,5	49,5	41,5	40	33,5			
B-NM 4025/B/B	NM 40/25B/B	11	15		69,5	69,5	69	68,5	67	65,5	63,5	60,5	53,5	51	45			
B-NM 4025A/B	NM 40/25A/B	15	20		90	90	89,5	89	88,5	87	85	83	77,5	76	70,5			

B-NM	NM	P <sub>2</sub>		Q m <sup>3</sup> /h l/min	24	27	30	33	37,8	42	48	54	60	66	69	72	75	78	81	84	
		kW	HP		400	450	500	550	630	700	800	900	1000	1100	1150	1200	1250	1300	1350	1400	
					H m																
B-NM 50/12F/A	NM 50/12F/B	2,2	3	H m			15,5	15	14	13,5	12	10	8	6							
B-NM 50/12D/A	NM 50/12D/B	3	4				20	19,5	18,5	18	16,5	14,5	13	10,5	9	8					
B-NM 50/12A/A	NM 50/12A/B	4	5,5				24	24	23	22,5	21	19,5	17,5	15	14	12,5	11,5	10			
B-NM 50/12S/A	NM 50/12S/B	4	5,5				26,5	26	25,5	24,5	23,5	22	20	18	16,5	15,5	14	13	11		
B-NM 50/160B/B	NM 50/16B/B	5,5	7,5				31	30,5	29,5	28	26	24	21,5	19	17,5	15,5	13,5	11,5	9,5		
B-NM 50/160A/B	NM 50/16A/B	7,5	10				38,5	38	37,5	36,5	34,5	32,5	30	27	25,5	24	22,5	20,5	19		
B-NM 50/200B/B	NM 50/20B/B	9,2	12,5		48	47,5	47,5	47	45,5	44,5	42,5	40	37	33	30,5	28	25,5	23			
B-NM 50/200A/B	NM 50/20A/B	11	15		55	55	54,5	54,5	53,5	52	50	48	45	41,5	39,5	37	35	32,5			
B-NM 50/200S/B	NM 50/20S/B	15	20		60	60	59,5	59,5	58,5	57,5	55,5	53,5	50,5	47	45	43	40,5	37			
B-NM 5025/C/B	NM 50/25C/B	11	15		55	54,5	54	53	51,5	49,5	46	41,5	35,5	28,5	24,5						
B-NM 5025/B/B	NM 50/25B/B	15	20		69	68,5	68	67,5	66	64	61	57	52,5	46,5	43						
B-NM 5025A/B	NM 50/25A/B	18,5	25		80,5	80,5	80	79,5	78,5	77	74,5	71,5	67	61,5	58,5						
B-NM 5025/65E/A	NM 50M/E/A	11	15			48	47,5	47	46	45	43	40	37	32	29,5	27	24				
B-NM 5025/65D/A	NM 50M/D/A	15	20				57	56,5	56	55	53	51	48	44,5	42	39,5	37	32	29	25*	
B-NM 5025/65C/A	NM 50M/C/A	18,5	25				68	67,5	67	66,5	65	63	61	58	56	53,5	51,5	48	45,5	42*	

B-NM - B-NMS	NM - NMS	P <sub>2</sub>		Q m <sup>3</sup> /h l/min	37,8	42	48	54	60	66	75	84	96	108	120	132	150	168		
		kW	HP		630	700	800	900	1000	1100	1250	1400	1600	1800	2000	2200	2500	2800		
					H m															
B-NM 65/125C/A	NM 65/12C/A	5,5	7,5	H m	18	17,5	17	16,5	16	15	13,5									
B-NM 65/125A/A	NM 65/12A/A	7,5	10		22	21,5	21	20,5	20	19,5	18	15,5								
B-NM 65/160E/A	NM 65/16E/A	5,5	7,5				20	19,5	19	18,5	17	15,5	13*	10*						
B-NM 65/160D/A	NM 65/16D/A	7,5	10				26	25,5	25	24,5	23,5	22	20*	16,5*	13*					
B-NM 65/160C/A	NM 65/16C/A	9,2	12,5				30	29,5	29	28,5	28	26,5	24,5*	21,5*	18*					
B-NM 65/160B/A	NM 65/16B/A	11	15				33,5	33	32,5	32	31	30	28*	25,5*	22*					
B-NM 65/160A/A	NM 65/16A/A	15	20				38	37,5	37	36,5	36	35	33*	30,5*	27*					
B-NM 65/200C/A	NM 65/20C/A	15	20				44	43,5	43	42,5	41	39,5	37,5	35	31	27*				
B-NM 65/200B/A	NM 65/20B/A	18,5	25				50	49,5	49	48,5	47,5	46,5	44,5	42	39	35*				
B-NM 65/200A/A	NM 65/20A/A	22	30				56,5	56	55,5	55	54,5	53,5	51	48,5	45,5	41,5*				
B-NM 65/250C/A	NM 65/25C/A	22	30				64	63,5	63	61,5	60	57,5	54,5*	50*						
B-NM 65/250B/A	NM 65/25B/A	30	40				79,5	79	78,5	78	77	75	72*	67*						
B-NMS 65/250A	NMS 65/250A	37	50				90	89,5	89	88,5	87,5	86	83,5*	78,5*						

### Performance n ≈ 2900 rpm

B-NM - B-NMS	NM - NMS	P <sub>2</sub>		Q m <sup>3</sup> /h l/min	75	84	96	108	120	132	150	168	180	192	210	240	270	300
		kW	HP		1250	1400	1600	1800	2000	2200	2500	2800	3000	3200	3500	4000	4500	5000
		H m																
B-NM 80/160E/A	NM 80/16E/A	7,5	10	20	19,3	18,5	17,5	16,5	15,5*	13*								
B-NM 80/160D/A	NM 80/16D/A	9,2	12,5	23	22,5	22	21	19,5	18*	15*								
B-NM 80/160C/A	NM 80/16C/A	11	15	27,5	27	26,5	25,5	24,5	23	20*	16*							
B-NM 80/160B/A	NM 80/16B/A	15	20	34	33,5	33	32,5	32	31	28*	23*	18*						
B-NM 80/160A/A	NM 80/16A/A	18,5	25	38,5	38	37,5	37	36,5	36	33*	29*	24*						
B-NMS 80/200B	NM 80/200B/A	22	30	46,5	46	45,5	44,5	43,5	42	39*	35,5*	32*						
B-NMS 80/200A	NM 80/200A/A	30	40	56	55,5	55	54	53	52	49,5*	46*	43*						
B-NMS 80/250E	NM 80/250E/A	22	30	51	50	48,5	46,5	44,5	42	38*	33*	29*						
B-NMS 80/250D	NM 80/250D/A	30	40	65	64	62,5	61	59	56,5	53*	49*	45,5*	41*					
B-NMS 80/250C	NMS 80/250C	37	50	73,5	73	72	70,5	69	67	63*	59*	55,5*	51,5*					
B-NMS 80/250B	NMS 80/250B	45	60	84	83,5	82,5	81,5	80	78	74,5*	70,5*	67*	63*					
B-NMS 80/250A	NMS 80/250A	55	75	95	94,5	93,5	92,5	91,5	90	87,5*	84*	80,5*	76,5*					
B-NMS 100/200E	NM 100/200E/A	18,5	25				30	29,5	29	28	27	26	25	23	19*			
B-NMS 100/200D	NM 100/200D/A	22	30				36	35,5	35	34	33	32	31	29	24,5*	19*		
B-NMS 100/200C	NM 100/200C/A	30	40				45	44,5	44	43,5	42,5	41,5	40,5	39	34,5*	29*	22°	
B-NMS 100/200B	NMS 100/200B	37	50				54	53,5	53	52,5	51,5	50,5	49,5	48	44*	38,5*	32°	
B-NMS 100/200A	NMS 100/200A	45	60				61,5	61	60,5	60	59,5	58,5	58	56,5	53*	48*	42°	
B-NMS 100/250B	NMS 100/250B	55	75				73,5	73	72,5	71,5	70	68,5	67	65	61*	55,5*	48,5°	
B-NMS 100/250A	NMS 100/250A	75	100				91	90,5	90	89,5	88,5	88	87	85	81*	75*	67°	

**NM(S)** Standard construction.  
**B-NM(S)** Bronze construction.

P<sub>2</sub> Rated motor power output.  
H Total head in m.

\* Maximum suction lift 1-2 m.  
◦ With 1 m suction head.

Tolerances according to UNI EN ISO 9906:2012

### Regulation (EU) No 547/2012

- The benchmark for most efficient water pumps is MEI ≥ 0,70.
- The efficiency of a pump with a trimmed impeller is usually lower than that of a pump with the full impeller diameter. The trimming of the impeller will adapt the pump to a fixed duty point, leading to reduced energy consumption. The minimum efficiency index (MEI) is based on the full impeller diameter.
- The operation of this water pump with variable duty points may be more efficient and economic when controlled, for example, by the use of a variable speed drive that matches the pump duty to the system.

### Rated currents

P <sub>2</sub>		230V Δ / 400V Y 400V Δ / 690V Y			I <sub>A</sub> /I <sub>N</sub>
kW	HP	I <sub>N</sub> A	I <sub>N</sub> A	I <sub>N</sub> A	
0,55	0,75	4	2,3		4,8
0,75	1	4	2,3		4,8
1,1	1,5	4,6	2,7		5,6
1,5	2	7,5	4,3		5,5
2,2	3	9,2	5,3		7,4
3	4	11,5	6,6		8,2
4	5,5		9,6	5,5	7,6
5,5	7,5		10,9	6,3	9,1
7,5	10		14,3	8,3	9,1
9,2	12,5		18,5	10,7	8,2
11	15		21,5	12,4	8,5
15	20		27,3	15,8	9,5
18,5	25		34	19,6	9,4
22	30		41	23,7	10,7
30	40		54	31,2	8,8
37	50		64	36,9	7,2
45	60		77	44,5	7,3
55	75		93	53,7	6,8
75	100		128	73,9	7

P<sub>2</sub> Rated motor power output.  
I<sub>A</sub>/I<sub>N</sub> D.O.L. starting current / Nominal current

Characteristic curves  $n \approx 2900$  rpm

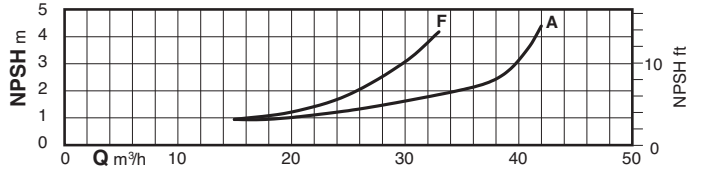
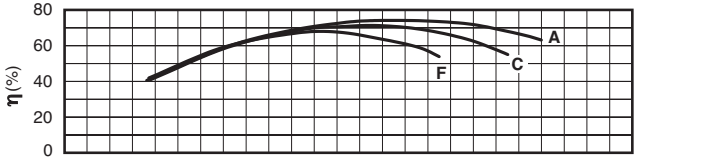
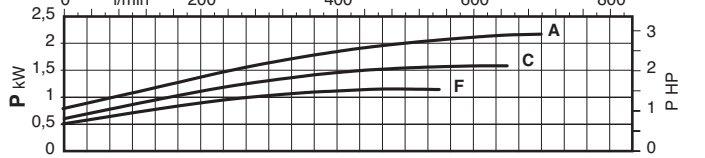
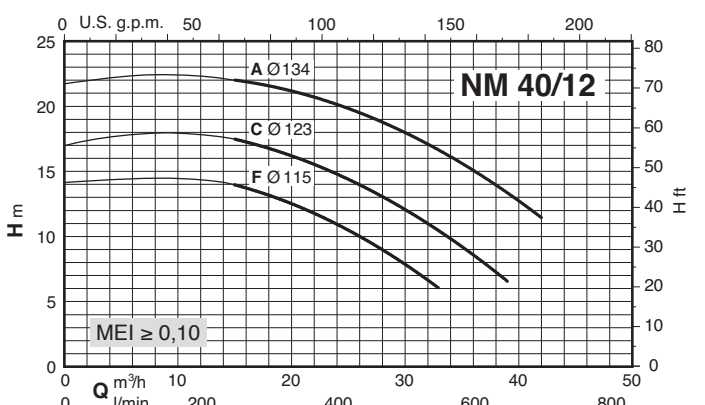
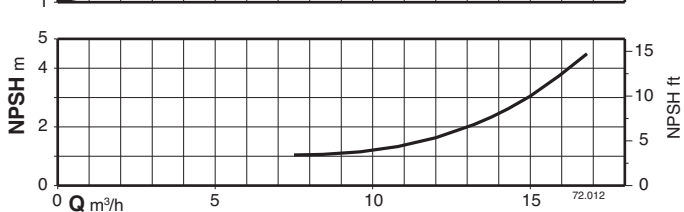
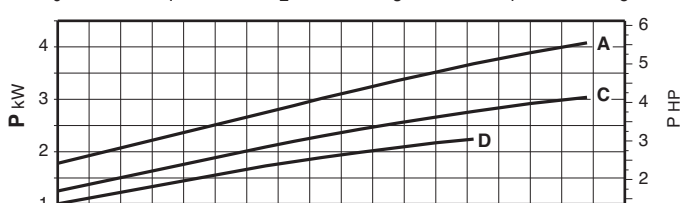
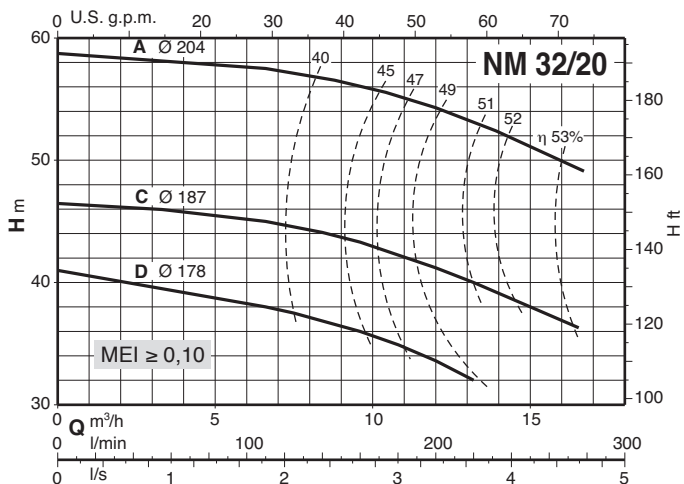
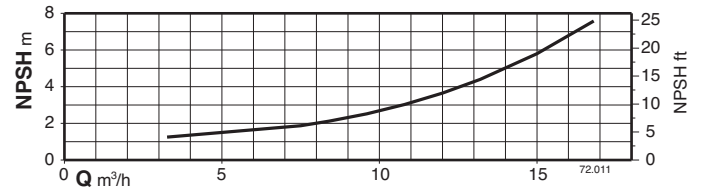
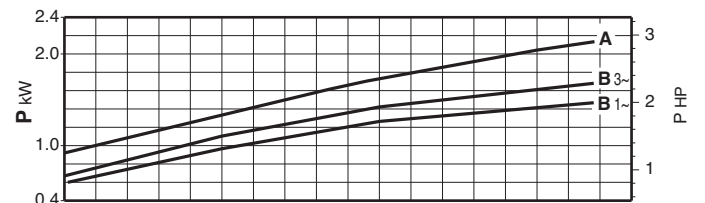
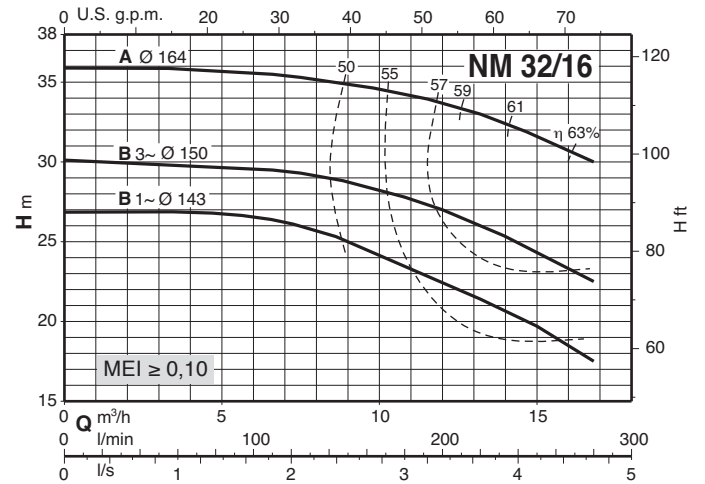
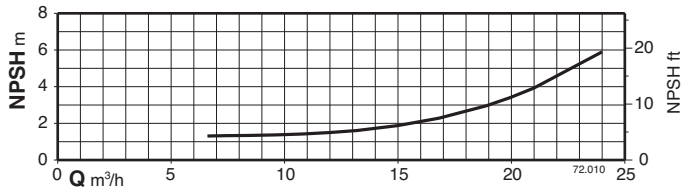
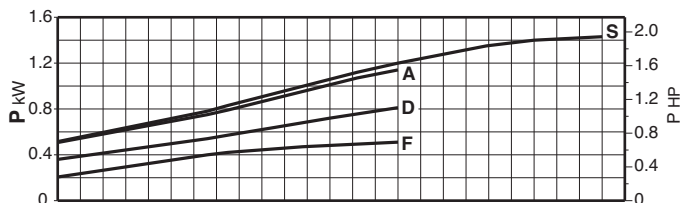
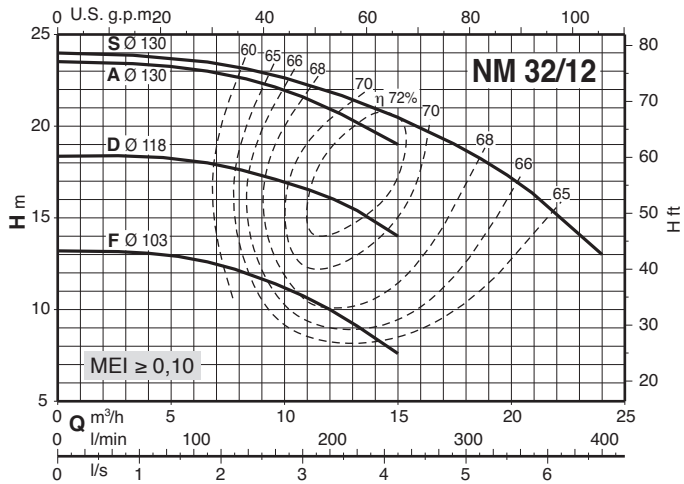

### Characteristic curves $n \approx 2900$ rpm

2

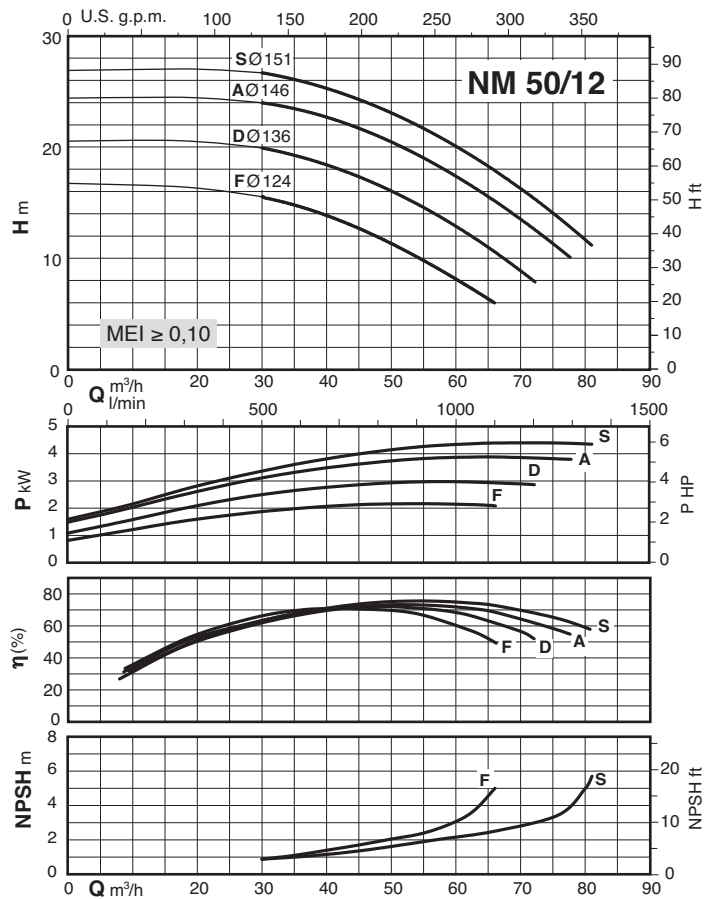
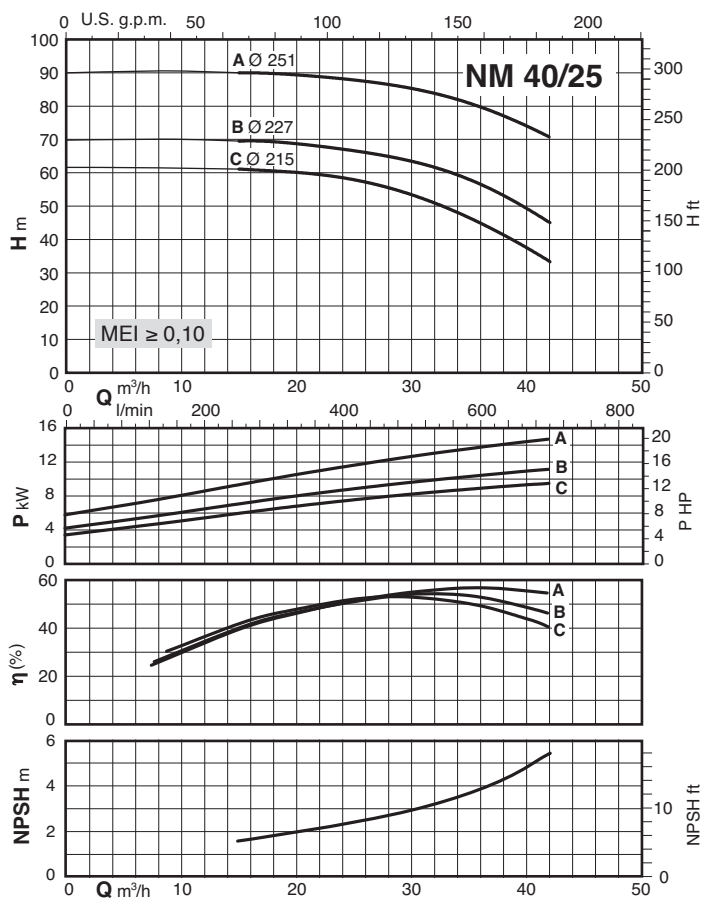
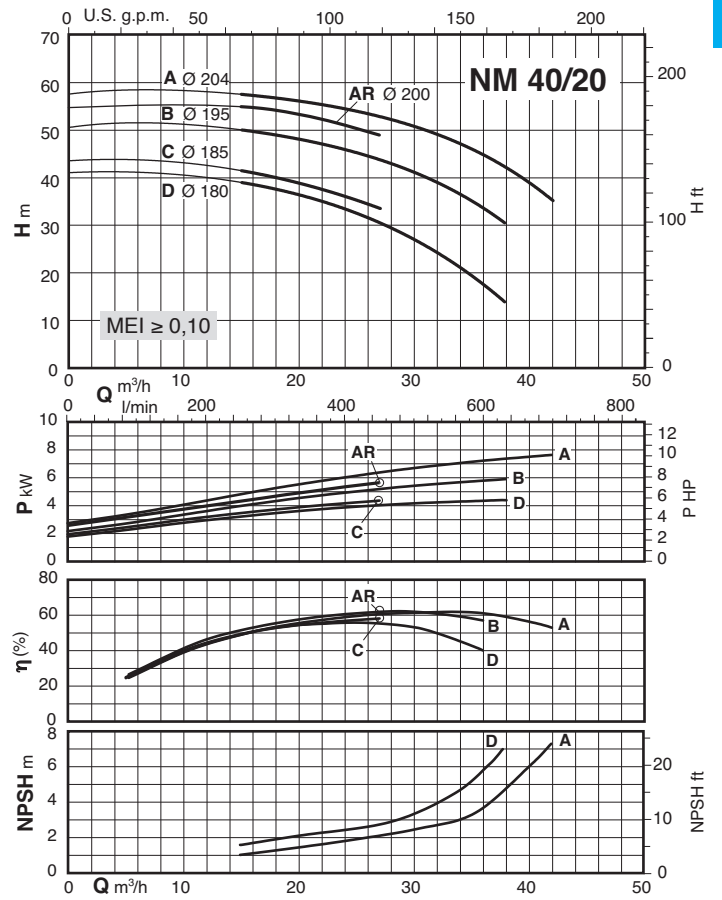
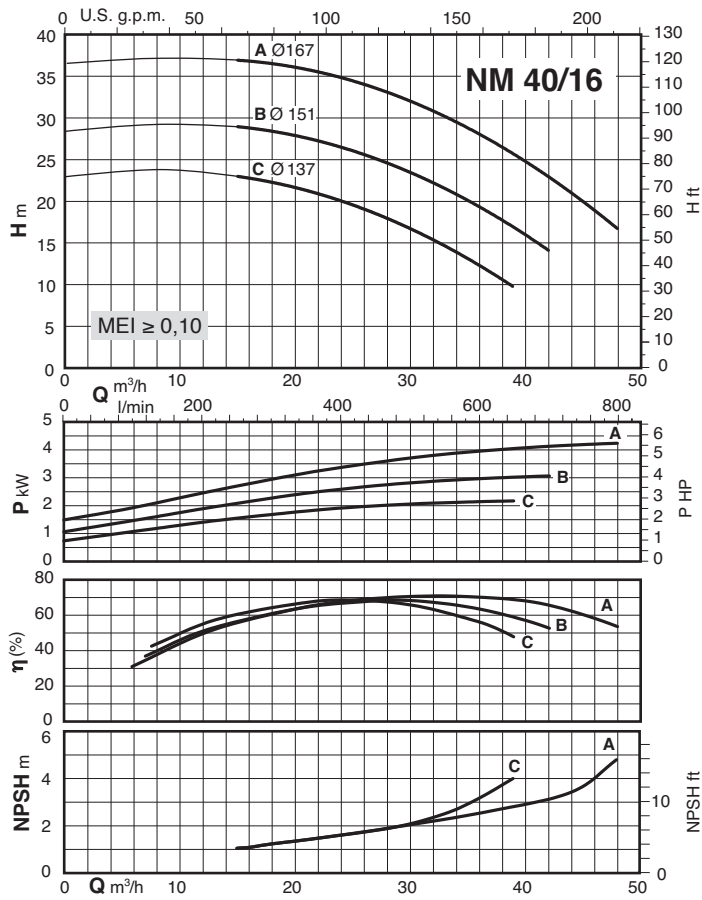

### Characteristic curves $n \approx 2900$ rpm

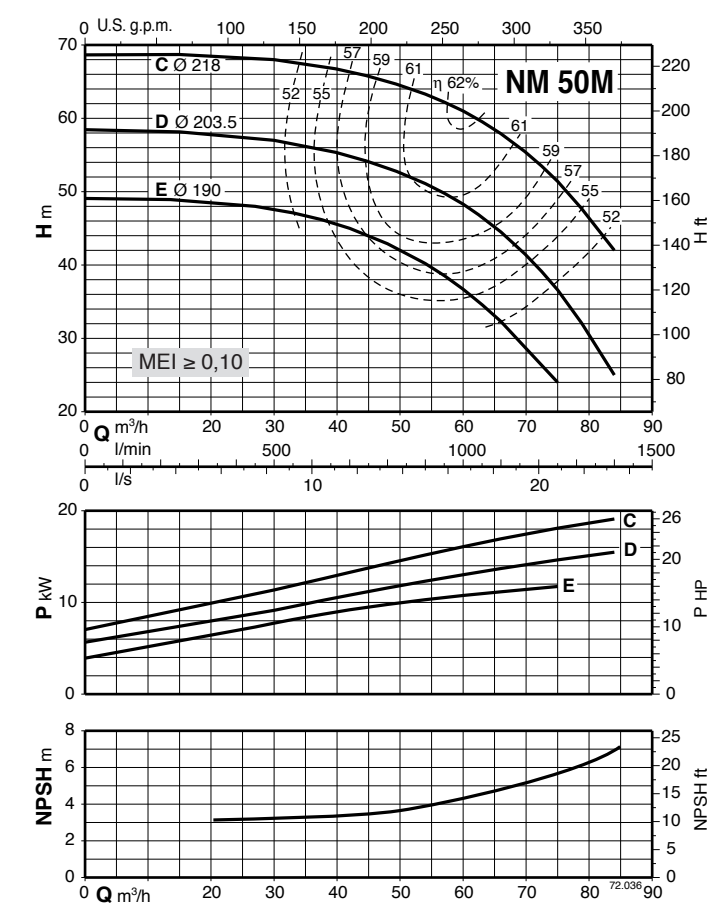
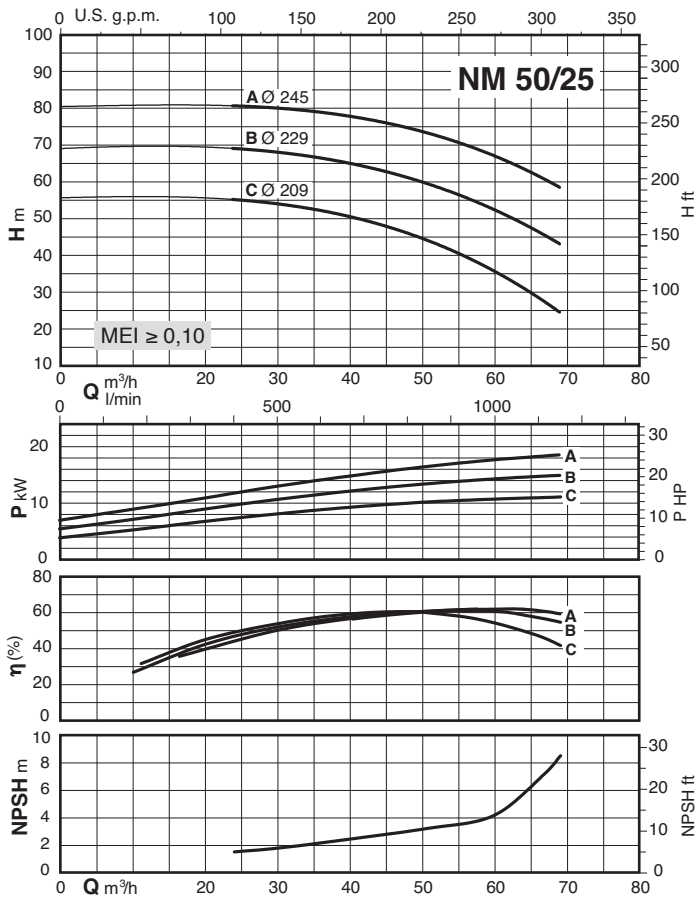
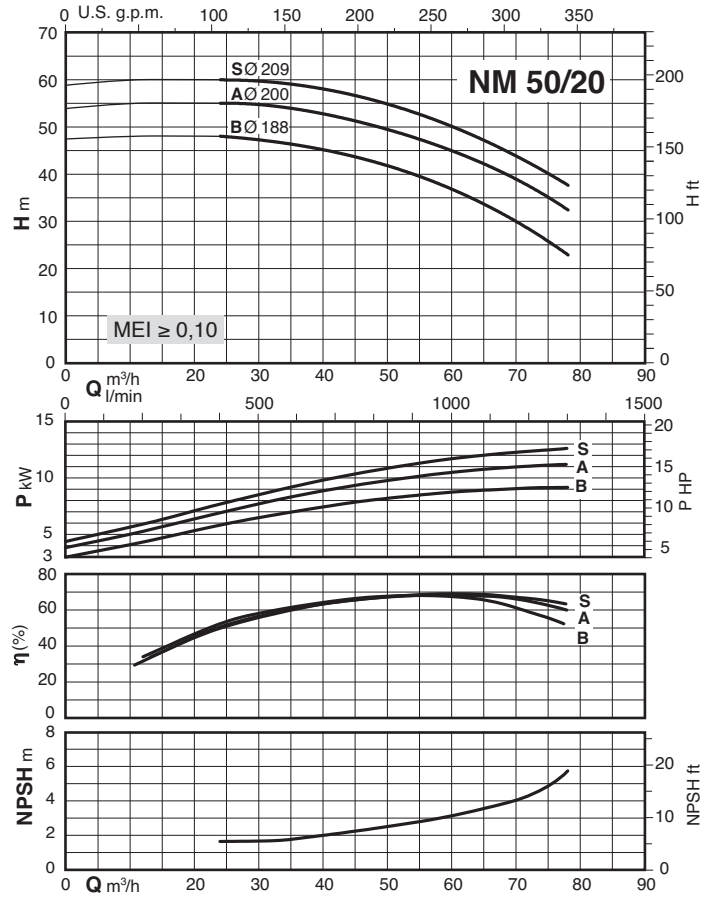
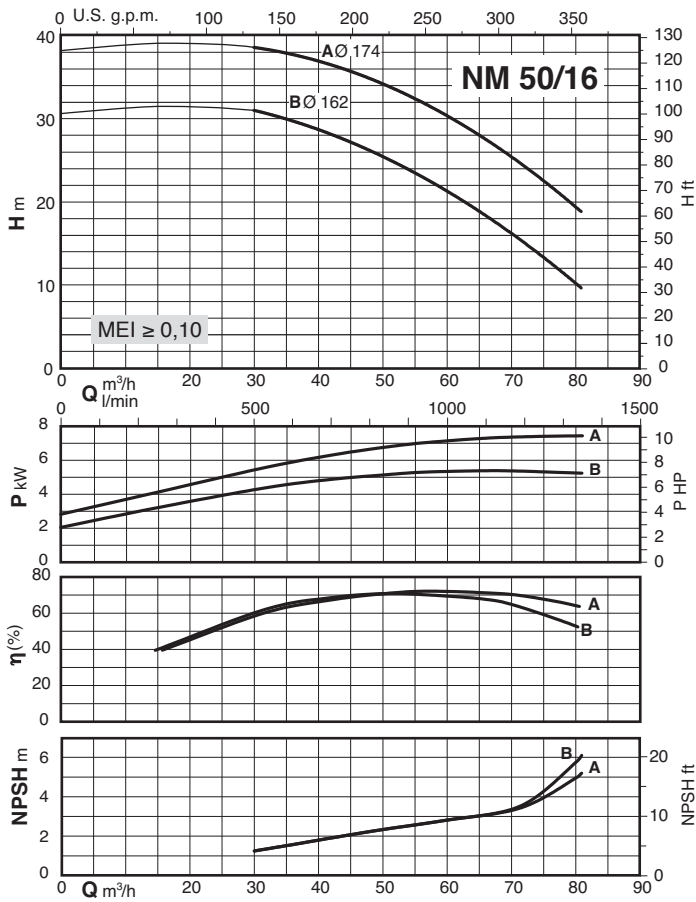

### Characteristic curves $n \approx 2900$ rpm

2

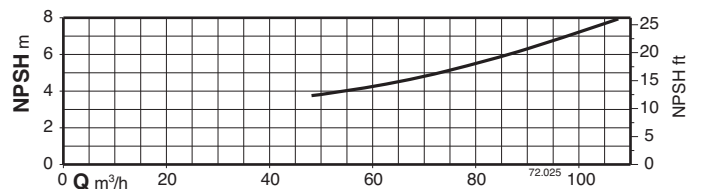
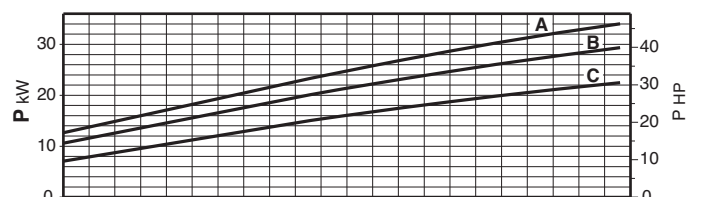
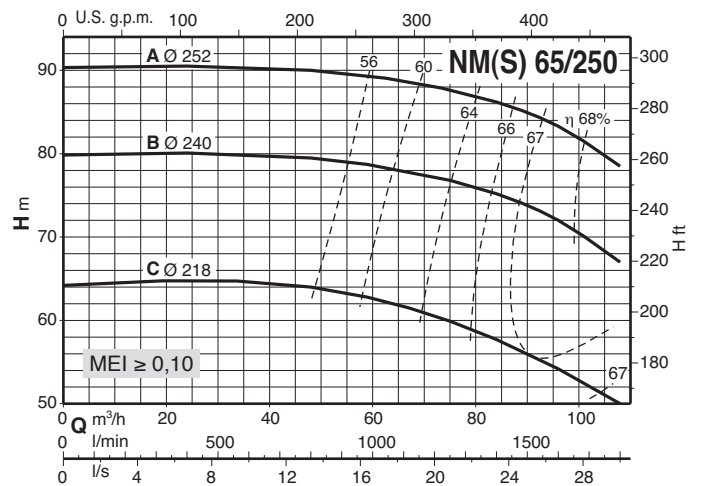
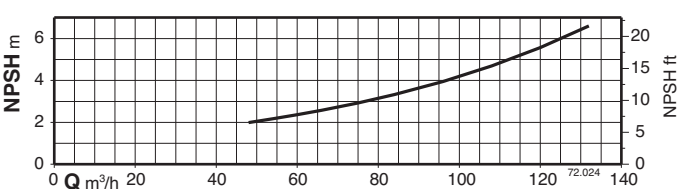
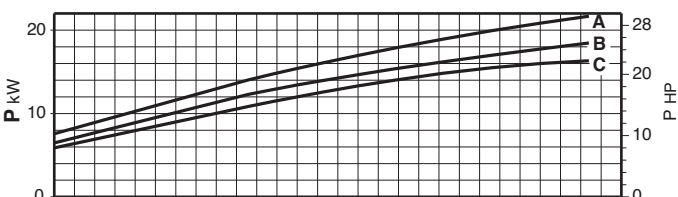
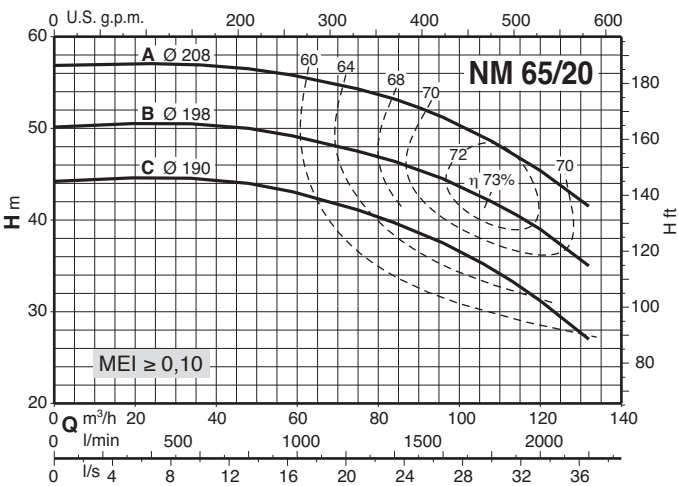
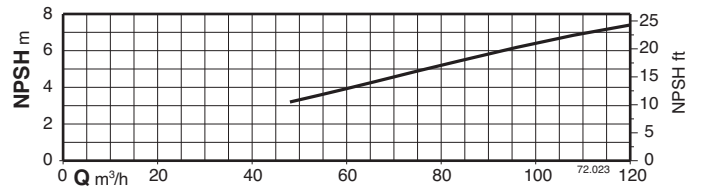
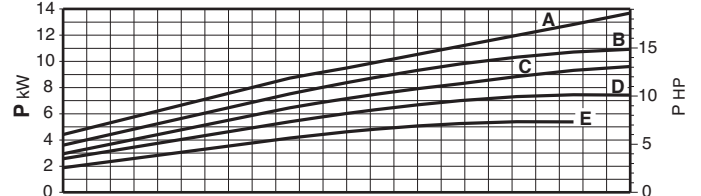
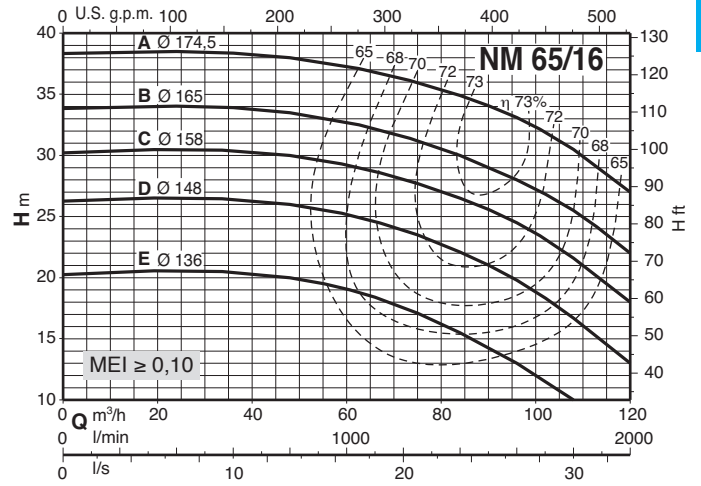
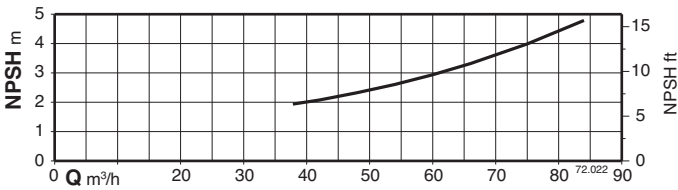
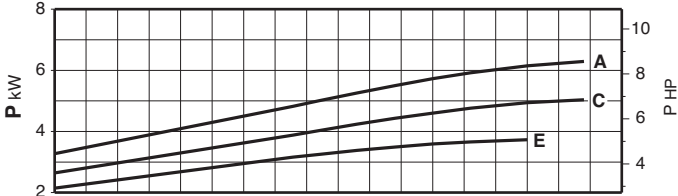
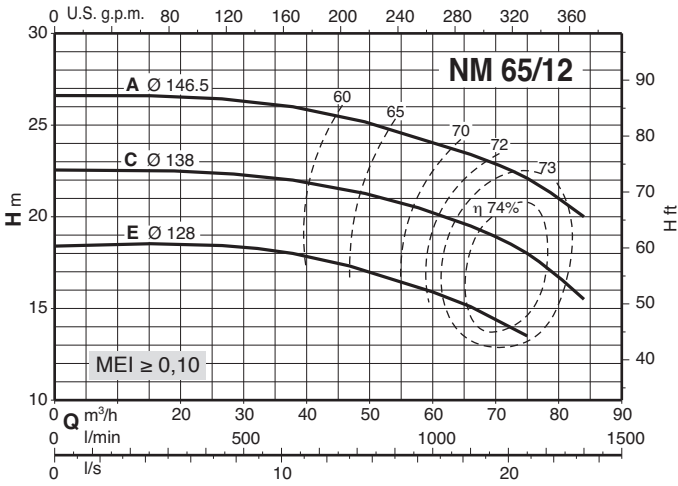

### Characteristic curves $n \approx 2900$ rpm

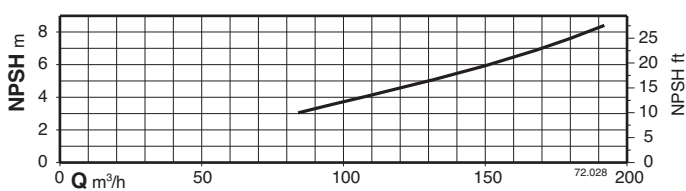
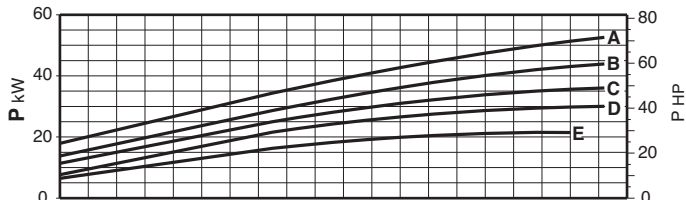
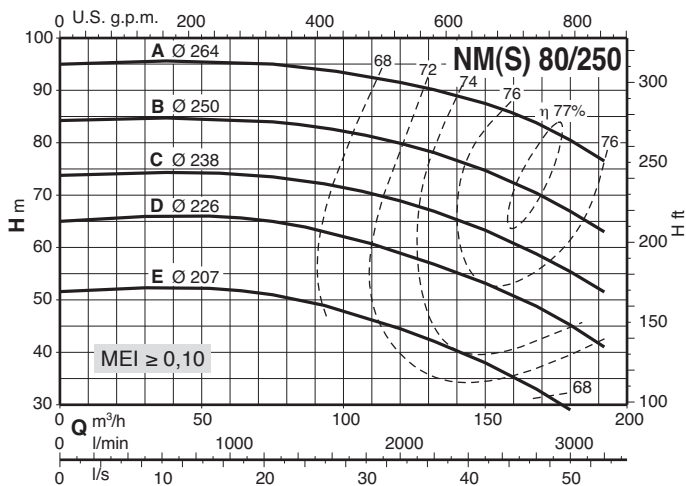
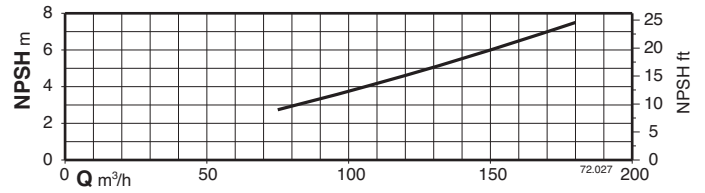
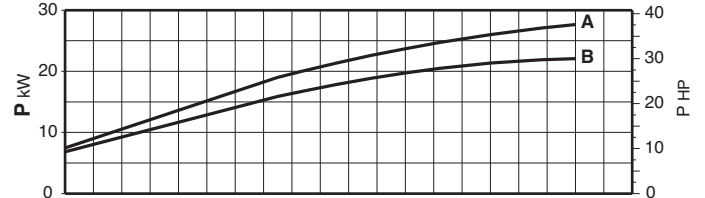
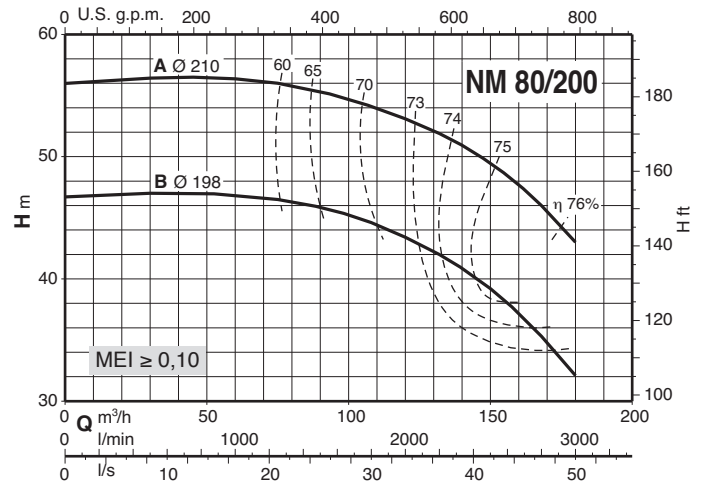
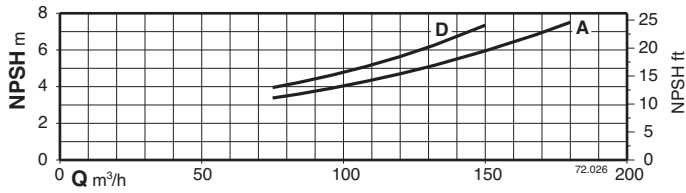
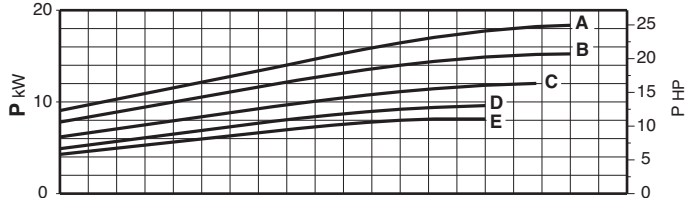
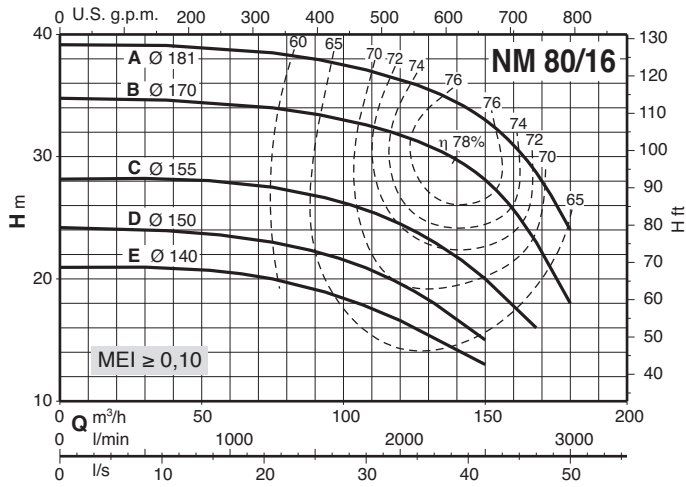



### Characteristic curves $n \approx 2900$ rpm

2

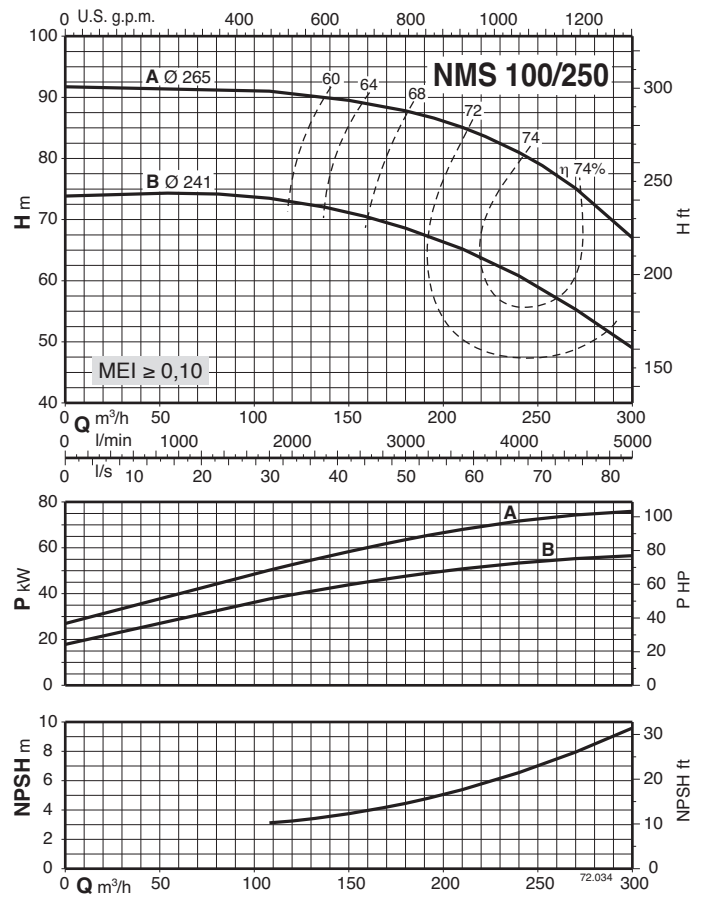
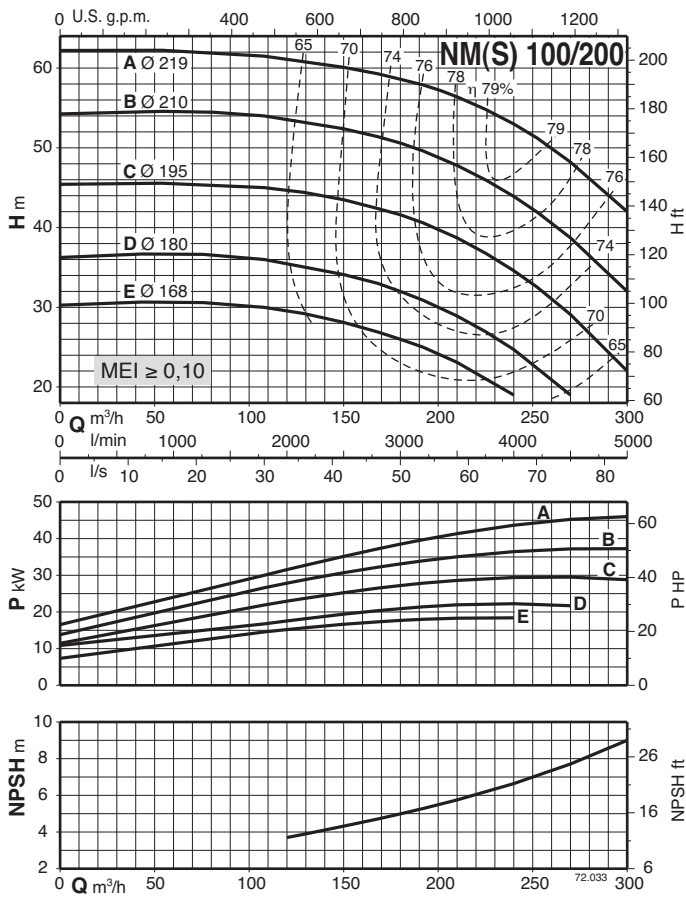

### Dimensions and weights

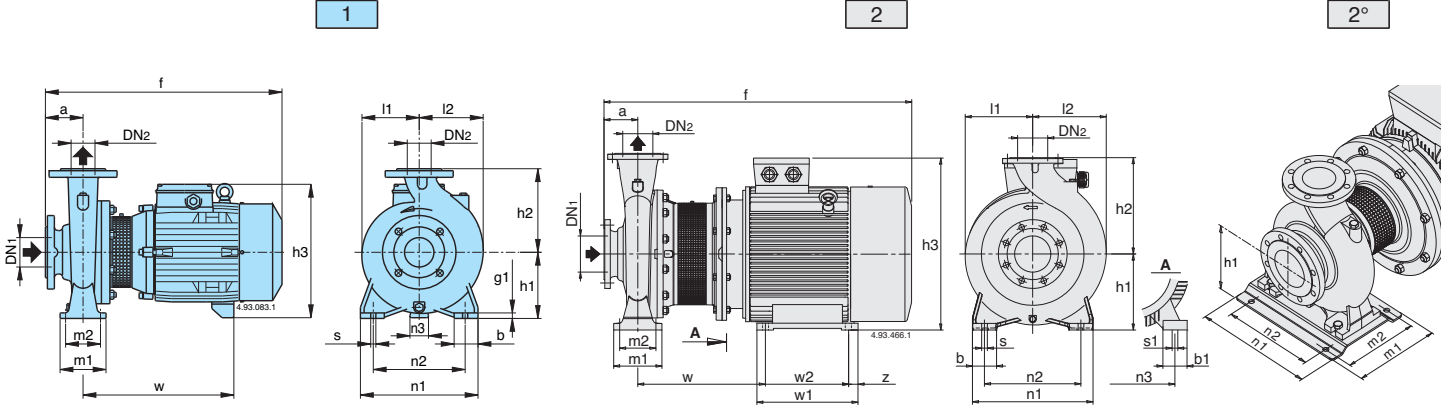

Picture	NM	mm																				kg					
		DN1	DN2	a	f	h1	h2	h3	h4	m1	m2	n1	n2	n3	z	b	b1	s	s1	l1	l2		w	w1	w2	g1	
1	NM 32/12SE-AE-DE-FE	50	32	80	405	112	140	240	-	100	70	190	140	37	-	50	-	14	-	93	97	245	-	-	12	27-25-24-24	
	NM 32/16BE NM 32/16A/A	50	32	80	410 450	132	160	260	-	100	70	240	190	47	-	50	-	14	-	120	120	250 290	-	-	12	34 39	
	NM 32/20D/A NM 32/20C/A NM 32/20A/A	50	32	80	450 475 475	160	180	288 298 298	-	100	70	240	190	60 60	-	50	-	14	-	140	140	290 295 295	-	-	12	42 52 52,5	
	NM 40/12C/A-F/A NM 40/12A/B	65	40	80	410 450	112	140	240	-	100	70	210	160	37	-	50	-	14	-	100	113	250 290	-	-	12	29-27 34	
	NM 40/16C/B NM 40/16B/B NM 40/16A/B	65	40	80	450 475 475	132	160	260 270 270	-	100	70	240	190	45 45	-	50	-	14	-	119	119	290 295 295	-	-	12	39 48 49,5	
	NM 40/20C/A-D/A NM 40/20A/A-AR/A-B/A	65	40	100	495 525	160	180	298 320	-	100	70	265	212	60 49	-	50	-	14	-	140	140	295 320	-	-	12	55,5-55,5 72,5-66-66	
	NM 40/25B/B-C/B NM 40/25A/B	65	40	100	640 715	180	225	365	-	125	95	320	250	50	-	65	-	14	-	175	175	400 460	-	-	15	116-110 145,5	
	NM 50/12F/B NM 50/12D/B NM 50/12A/B-S/B	65	50	100	470 495 495	132	160	260 270	-	100	70	240	190	45 45	-	50	-	14	-	121	137	290 295 295	-	-	12	41 50 51,5	
	NM 50/16A/B-B/B	65	50	100	525	160	180	320	-	100	70	265	212	49	-	50	-	14	-	127	141	320	-	-	14	70,5-64	
	NM 50/20A/B-B/B NM 50/20S/B	65	50	100	640 720	160	200	345	-	100	70	265	212	40	-	50	-	14	-	140	153	410 410	-	-	15	106-100 124,5	
	NM 50/25C/B NM 50/25B/B NM 50/25A/B	65	50	100	645 720 720	180	225	365	-	125	95	320	250	50	-	65	-	14	-	175	175	415 465 465	-	-	15	126 144,5 153	
	NM 50M/E/A NM 50M/D/A NM 50M/C/A	65	50	100	645 720 720	180	225	365	-	125	95	320	250	50	-	65	-	14	-	175	175	415 465 465	-	-	15	117,5 144 162	
	NM 65/12E/A NM 65/12A/A-C/A	80	65	100	495 525	160	180	298 320	-	125	95	280	212	60 49	-	65	-	14	-	134	156	295 320	-	-	15	55,5 73,5-68	
	NM 65/16D/A-E/A NM 65/16B/A-C/A NM 65/16A/A	80	65	100	525 640 715	160	200	320 345 345	-	125	95	280	212	40 40	-	65	-	14	-	150	172	320 410 460	-	-	15	75-70 106-100 133,5	
	NM 65/20C/A NM 65/20B/A	80	65	100	715	180	225	365	-	125	95	320	250	50	-	65	-	14	-	155	175	460	-	-	15	139,5 145	
	4	NM 65/200A/A	80	65	100	825	202	225	408	22	125	95	320	250	254	20	80	90	18	14	155	175	245	400	360	42*	185
		NM 65/250B/A-C/A	80	65	100	825	202	250	408	2	160	120	360	280	254	20	80	90	18	14	175	190	245	400	360	42*	201-195
	1	NM 80/16E/A NM 80/16C/A-D/A NM 80/16B/A NM 80/16A/A	100	80	125	545 670 745 745	180	225	340 365 365 365	-	125	95	320	250	60 50 50 50	-	65	-	14	-	165	193	320 415 465 465	-	-	15	83,5 113-108 142,5 150
		NM 80/200A/A-B/A	100	80	125	850	202	250	408	22	160	120	345	280	254	20	80	90	18	14	170	194	245	400	360	42*	200-194
		NM 80/250D/A-E/A	100	80	125	850	202	280	408	2	160	120	400	315	254	20	80	90	18	14	191	210	245	400	360	42*	209-203
		NM 100/200E/A NM 100/200C/A-D/A	125	100	125	800 850	200 202	280	345 408	- 2	160	120	360	280	216 254	20 20	80	69 90	18	12 14	180	212	239 245	298 400	258 360	6 42*	179 201-195

Flanges EN 1092-2

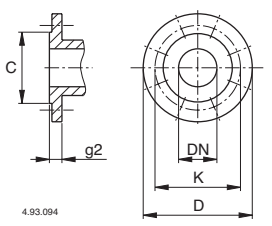

mm						
DN	C	K	D	Holes		g2
				N°	Ø	
32	76	100	140	4	19	18
40	84	110	150	4	19	18
50	99	125	165	4	19	20
65	118	145	185	4	19	20
80	132	160	200	8	19	22
100	156	180	220	8	19	24
125	184	210	250	8	19	24

Picture	NMS	mm																				kg				
		DN1	DN2	a	f	h1	h2	h3	h4	m1	m2	n1	n2	n3	z	b	b1	s	s1	l1	l2		w	w1	w2	g1
2	NMS 65/250A	80	65	100	1074	200	250	500	-	160	120	360	280	318	-	80	70	18	19	200	200	406	355	305	-	347
	NMS 80/250C	100	80	125	1099	200	280	500	-	160	120	400	315	318	-	80	70	18	19	200	210	406	355	305	-	416
2°	NMS 80/250B	100	80	125	1164	225	280	550	-	298	258	410	315	356	-	80	18	19	225	225	445	361	311	-	416	
3°	NMS 80/250A	100	80	125	1235	280	280	672	-	260	220	410	315	406	25	-	100	18	24	275	275	443	500	450	8	512
2	NMS 100/200B	125	100	125	1099	200	280	500	-	160	120	360	280	318	-	80	70	18	19	200	212	406	355	305	-	345
2°	NMS 100/200A	125	100	125	1164	225	280	550	-	298	258	410	315	356	-	80	18	19	225	225	445	361	311	-	409	
3°	NMS 100/250B	125	100	140	1250	280	280	672	-	260	220	410	315	440	25	-	100	18	24	275	275	443	500	450	8	512
2°	NMS 100/250A	125	100	140	1324	280	280	712	-	260	220	410	315	457	-	-	100	18	24	275	275	516	479	368	-	512

Pumps with packed gland, dimensions available on request (excluded NMS).

### Dimensions and weights

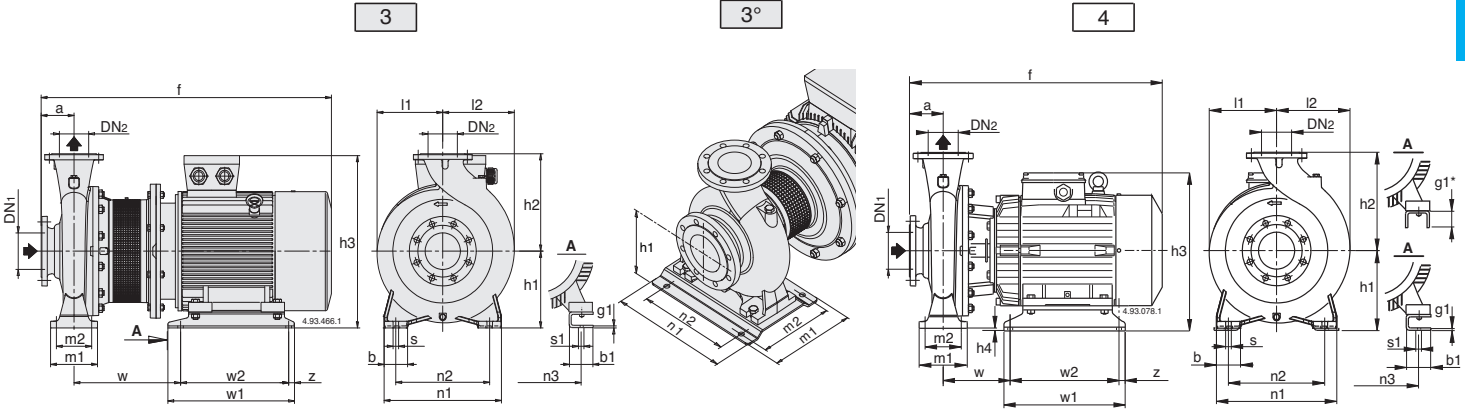

Picture	B- NM	mm																						kg			
		DN1	DN2	a	f	h1	h2	h3	h4	m1	m2	n1	n2	n3	z	b	b1	s	s1	l1	l2	w	w1	w2	g1	B-NM	
1	B-NM 32/12S-A-D-F	50	32	80	405	112	140	240	-	100	70	190	140	37	-	50	-	14	-	93	97	245	-	-	12	33-32-31-29	
	B-NM 32/16B B-NM 32/16A/A	50	32	80	410 450	132	160	260	-	100	70	240	190	47	-	50	-	14	-	120	120	250 290	-	-	12	44 48	
	B-NM 32/20D/A B-NM 32/20C/A B-NM 32/20A/A	50	32	80	450 475 475	160	180	288 298 298	-	100	70	240	190	45 60 60	-	50	-	14	-	140	140	290 295 295	-	-	12	52 60 61,5	
	B-NM 40/12C-F B-NM 40/12A/A	65	40	80	410 450	112	140	240	-	100	70	210	160	37	-	50	-	14	-	100	113	250 290	-	-	12	35-33 40	
	B-NM 40/16C/A B-NM 40/16B/A B-NM 40/16A/A	65	40	80	450 475 475	132	160	260 270 270	-	100	70	240	190	45 45 45	-	50	-	14	-	119	119	290 295 295	-	-	12	48 56 57,5	
	B-NM 40/20C/A-D/A B-NM 40/200A/A-B/A	65	40	100	495 580	160	180	298 320	-	100	70	265	212	60 49	-	50	-	14	-	140	140	295 375	-	-	12	63,5-62,5 80,5-75	
	1*	B-NM 4025/B/B-C/B B-NM 4025/A/B	65	40	100	635 705	192	225	377	12	125	95	320	250	216	20	65	69	14	12	175	175	174	298	258	6	130-124 159,5
1	B-NM 50/12F/A B-NM 50/12D/A B-NM 50/12A/A-S/A	65	50	100	470 495 495	132	160	260 270 270	-	100	70	240	190	45 45 45	-	50	-	14	-	121	137	290 295 295	-	-	12	52 61 63,5-63,5	
	1*	B-NM 50/160A/B-B/B	65	50	100	580	160	180	320	-	100	70	265	212	49	-	50	-	14	-	127	141	375	-	-	14	80,5-74,5
	4	B-NM 50/200A/B-B/B B-NM 50/200S/B	65	50	100	695 720	192	200	377	32	100	70	265	212	216	20	65	69	14	12	140	153	234	298	258	6	128-121 140,5
B-NM 5025/C/B B-NM 5025/B/B B-NM 5025/A/B		65	50	100	635 710 710	192	225	377	12	125	95	320	250	216	20	65	69	14	12	175	175	174	298	258	6	135 144 161	
B-NM 5025/65E/A B-NM 5025/65D/A B-NM 5025/65C/A		65	50	100	635 710 710	192	225	377	12	125	95	320	250	216	20	65	69	14	12	175	175	174	298	258	6	135 156,5 161	
1*		B-NM 65/125A/A-C/A B-NM 65/160D/A-E/A B-NM 65/160C/A	80	65	100	580 575 660	160	200	320 345	-	125	95	280	212	49 40	-	65	-	14	-	150	172	375 430	-	-	15	93,5-73 83,5-79 108
4	B-NM 65/160B/A B-NM 65/160A/A	80	65	100	695 770	192	200	377	32	125	95	280	212	216	20	65	69	14	12	150	172	234	298	258	6	149 178,5	
	B-NM 65/200B/A-C/A B-NM 65/200A/A	80	65	100	775 825	192	225	377 408	12 22	125	95	320	250	216 254	20	65	69 90	14 14	12 14	155	175	239 245	298 400	258 360	6 42*	183-169,5 200	
	B-NM 65/250B/A-C/A	80	65	100	825	202	250	408	2	160	120	360	280	254	20	80	90	18	14	175	190	245	400	360	42*	216-210	
1*	B-NM 80/160E/A B-NM 80/160D/A	100	80	125	605 685	180	225	340 365	-	125	95	320	250	60 50	-	65	-	14	-	165	193	375 430	-	-	15	108,5 116	
	4	B-NM 80/160C/A B-NM 80/160B/A B-NM 80/160A/A	100	80	125	725 800 800	192	225	377	12	125	95	340	250	216	20	65	69	14	12	165	193	239	298	258	6	155 175,5 182

Flanges EN 1092-2

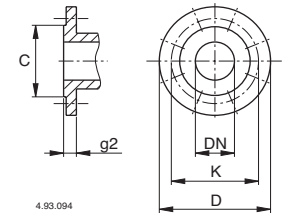

DN	C	K	D	Holes		g2
				N°	Ø	
32	76	100	140	4	19	18
40	84	110	150	4	19	18
50	99	125	165	4	19	20
65	118	145	185	4	19	20
80	132	160	200	8	19	22
100	156	180	220	8	19	24
125	184	210	250	8	19	24

Picture	B-NMS	mm																						kg	
		DN1	DN2	a	f	h1	h2	h3	h4	m1	m2	n1	n2	n3	z	b	b1	s	s1	l1	l2	w	w1		w2
2	B-NMS 65/250A	80	65	100	1074	200	250	500	-	160	120	360	280	318	-	80	70	18	19	200	200	406	355	305	-
3	B-NMS 80/200A-B B-NMS 80/250D-E	100	80	125	936 936	180	250	387 407	-	125	95	345	280	254	20	65	60	14	15	175	194	331	350	310	5
2	B-NMS 80/250C	100	80	125	1099	200	280	500	-	160	120	400	315	318	-	80	70	18	19	200	210	406	355	305	-
2°	B-NMS 80/250B	100	80	125	1164	225	280	550	-	298	258	410	315	356	-	-	80	18	19	225	225	445	361	311	-
3°	B-NMS 80/250A	100	80	125	1235	280	280	672	-	260	220	410	315	406	25	-	100	18	24	275	275	443	500	450	8
3	B-NMS 100/200E B-NMS 100/200C-D	125	100	125	882 936	200	280	386 407	-	160	120	360	280	216	20	80	69	18	12	180	212	322	298	258	6
2	B-NMS 100/200B	125	100	125	1099	200	280	500	-	160	120	360	280	318	-	80	70	18	19	200	212	406	355	305	-
2°	B-NMS 100/200A	125	100	125	1164	225	280	550	-	298	258	410	315	356	-	-	80	18	19	225	225	445	361	311	-
3°	B-NMS 100/250B	125	100	140	1250	280	280	672	-	260	220	410	315	440	25	-	100	18	24	275	275	443	500	450	8
2°	B-NMS 100/250A	125	100	140	1324	280	280	712	-	260	220	410	315	457	-	-	100	18	24	275	275	516	479	368	-

\* Version without coupling guard

### Features

#### Cutting edge hydraulics

The geometry of the impeller and the pump casing are optimized to achieve maximum efficiency and the best suction capability.

#### Flexible

The option to choose between cast iron and bronze materials for the hydraulic parts in contact with the pumped liquid allows NM and NM4 series pumps to be selected for use with different types of liquids.

#### Compact Design

The compact design allows for easy installation even in confined spaces.

#### Exclusive design

An innovative, patented guard prevents contact with rotating parts, providing protection to the end user whilst allowing for inspection of the mechanical seal.

#### Reliable

The bearing and shaft are designed to ensure the reduction of the stress, providing high reliability under all operating conditions.

NM

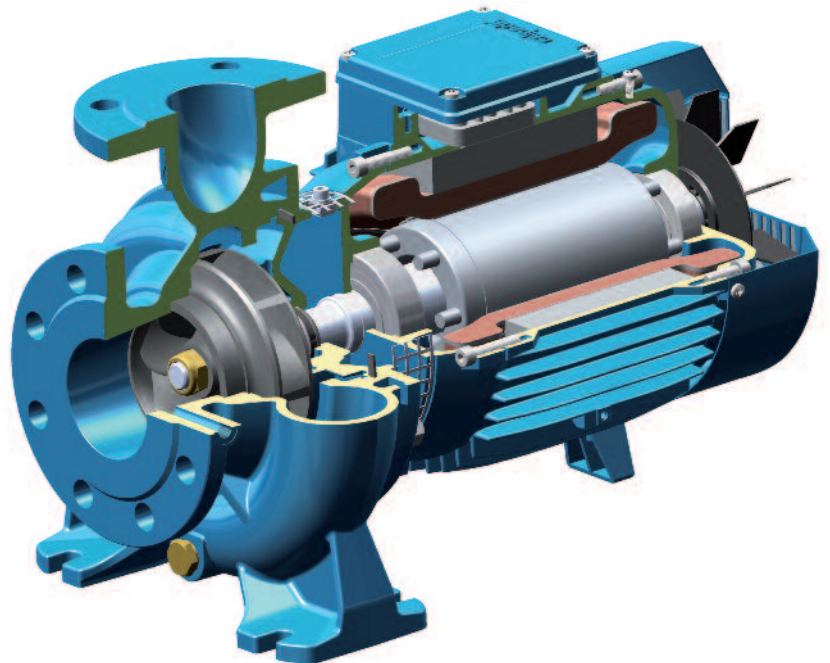

#### Cutting edge hydraulics

The geometry of the impeller and the pump casing are optimized to achieve maximum efficiency and the best suction capability.

#### Flexible

The option to choose between cast iron and bronze materials for the hydraulic parts in contact with the pumped liquid allows NMS and NMS4 series pumps to be selected for use with different types of liquids.

#### New lantern bracket construction

The lantern brackets incorporate a thrust bearing on the hydraulic side which guarantees the elimination of additional loads on the motor bearings. The flange is sized to be used with standard motors B35.

#### Exclusive design

An innovative, patented guard prevents contact with rotating parts, providing protection to the end user whilst allowing for inspection of the mechanical seal.

#### Simplified motor maintenance

The presence of the thrust bearing on the hydraulic side makes it easier to remove the motor, facilitating maintenance operations and eliminating the risks of damage to the hydraulic parts.

NMS

